









	GU10 LAMP	IP 20						
1x GU10 50W MAX Included Lamp-holder Recessed Material: Aluminium								

Please read instructions before commencing installation and retain for future reference.

INSTALLATION INSTRUCTIONS

! Electrical products can cause death, injury, or damage to property. Maintenance and installation should only be carried out by a professional electrician.

- Ensure main supply is switched off.
- Cut Out Hole Ø75mm and Depth 105mm required into the mounting surface.
- Move the springs to an upright position.
- Insert the spot inside of the hole and return the springs to a vertical position.
- Install the GU10 bulb and lock it onto the lump-holder.
- Add the locking ring clip to hold the bulb.
- Reconnect power.

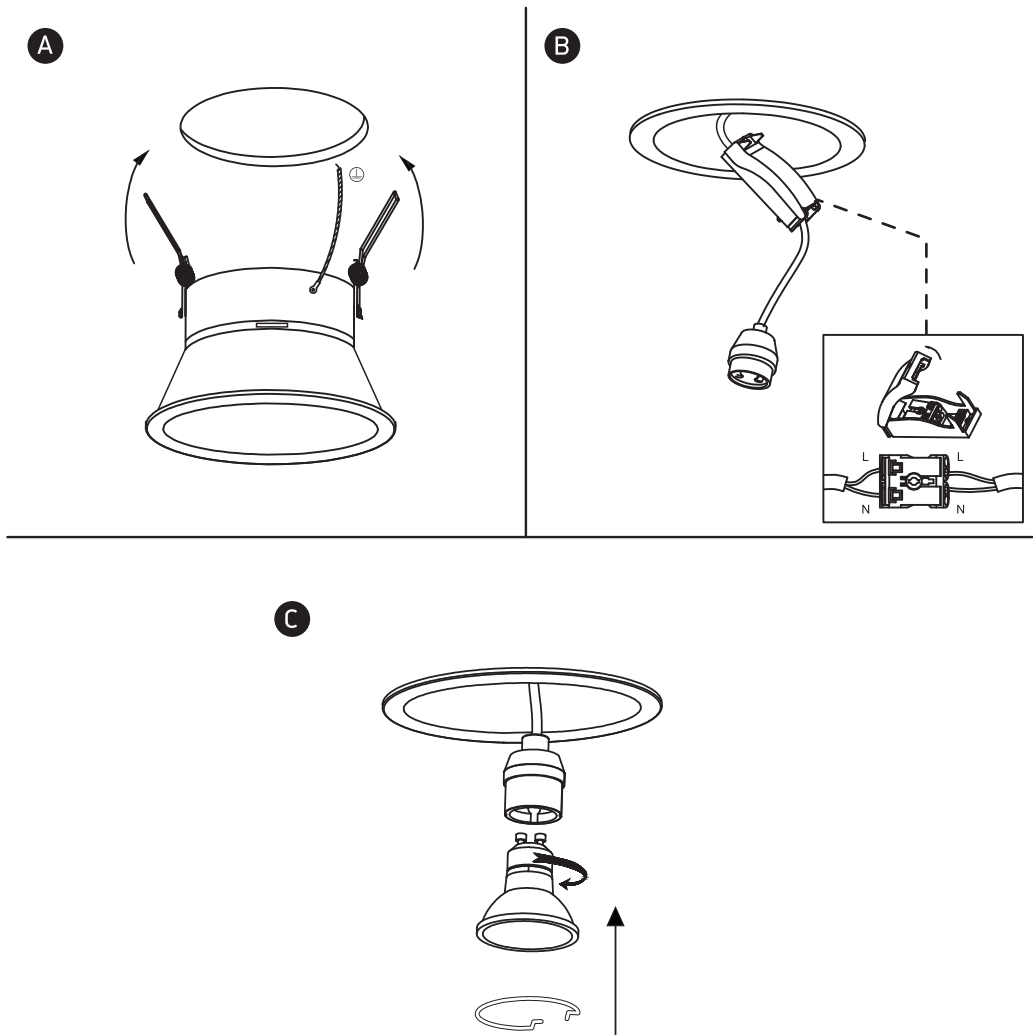

WARNING

- Make sure that the products is installed properly before connecting to electricity.
- Do not cover the fitting.
- Not for outdoor use or in wet conditions.
- Do not exceed the maximum wattage rating of the lamp.

