

Connecting the Terminal Block

Connect main supply (brown - Live, blue - Neutral) into terminal block making sure all connections are tight.

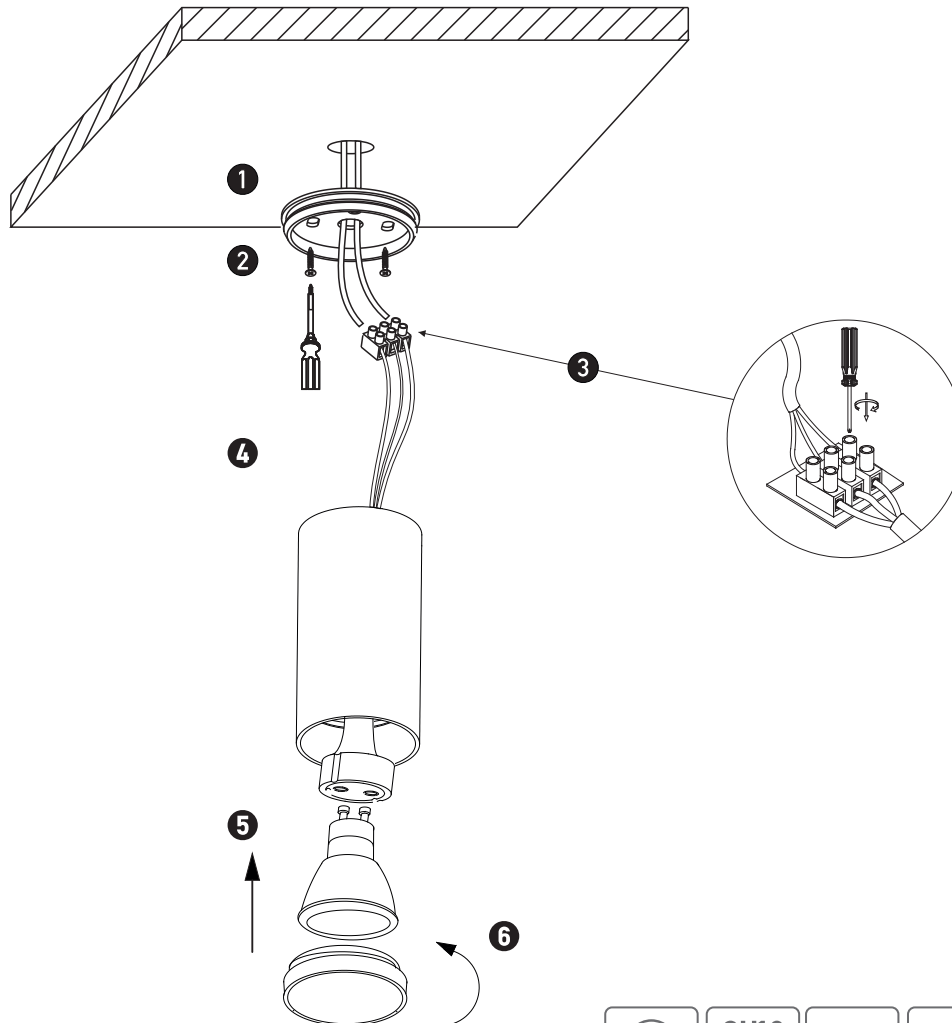

CEILING SPOT

S001

Please read instructions before commencing installation and retain for future reference.

SPECIFICATIONS

- **Material:** Aluminium
- **Lamp type:** 1x GU10 , 40W MAX
- **Ingress Protection:** IP20. Protection against entry of solid objects greater than 12mm in diameter.

INSTALLATION INSTRUCTIONS

⚠ Electrical products can cause death, injury, or damage to property. Maintenance and installation should only be carried out by a professional electrician.

- Ensure main supply is switched off.
- Insert masonry plugs (1) into the mounting surface.
- Fit mounting bracket onto the mounting surface with self-tapping screws (2).
- Connect main supply wires to terminal block (3) making sure all connections are tight.
- Twist the ceiling spot to lock it onto the mounting bracket (4).
- Install the GU10 bulb to lock it onto the lamp-holder (5).
- Twist the cover to lock it onto the spot (6).
- Reconnect power.

WARNING

- Make sure that the products is installed properly before connecting to electricity.
- Do not cover the fitting.
- Not for outdoor use or in wet conditions.
- Do not exceed the maximum wattage rating of the lamp.

