

GARDEN LED LIGHT

E286 WITH SPIKE 

Please read instructions before commencing installation and retain for future reference.

SPECIFICATIONS

- **Material:** Aluminum - Tempered Glass
- **Lamp type:** LED , 12W , 3000K , 780Lm , CRI 80
- **Ingress Protection:** IP65. Protection against entry of solid objects greater than 12mm in diameter.

INSTALLATION INSTRUCTIONS

 Electrical products can cause death, injury, or damage to property. Maintenance and installation should only be carried out by a professional electrician.

 The light source contained in this luminaire shall only be replaced by the manufacturer or his service agent or a similar qualified person.

- Ensure main supply is switched off.

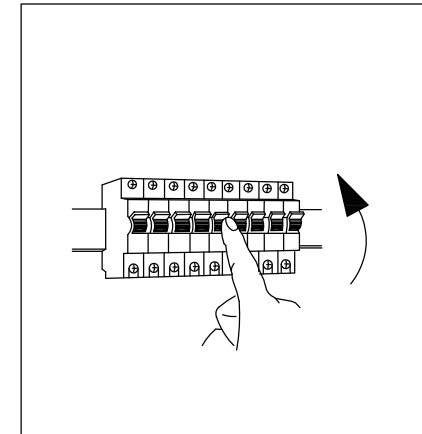
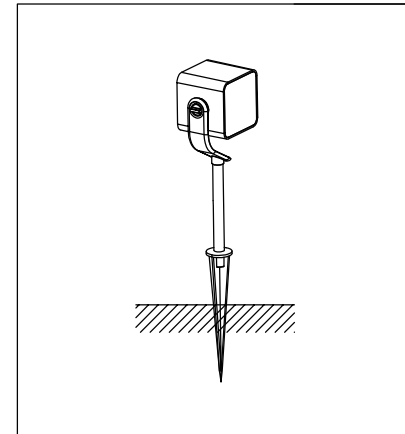
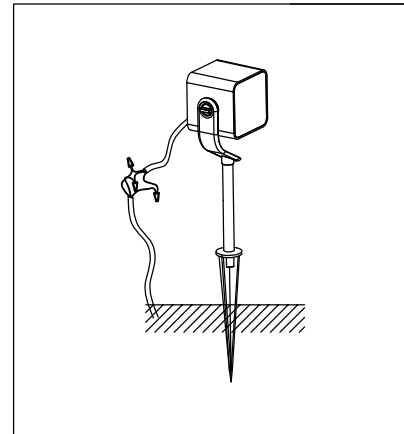
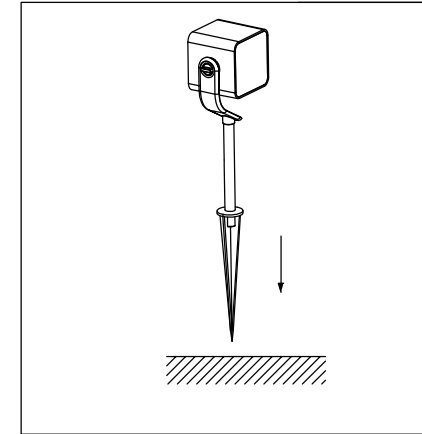
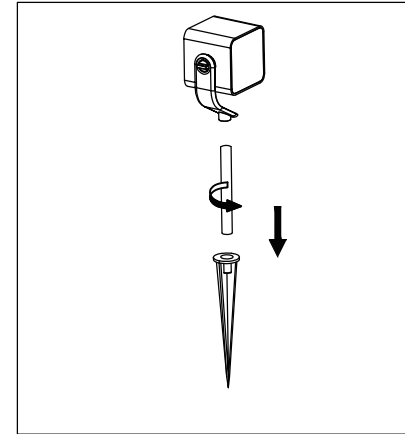
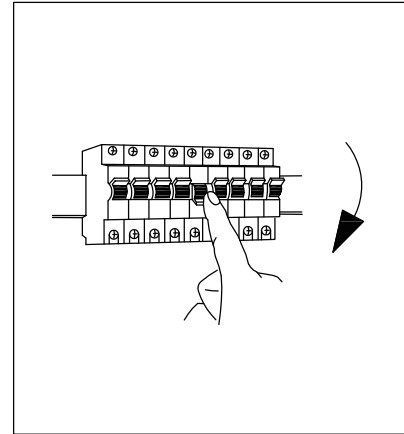
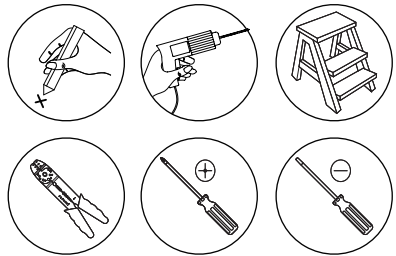

WARNING

- Make sure that the products is installed properly before connecting to electricity.
- Do not cover the fitting.

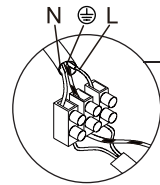

Connecting the Terminal Block

Connect main supply (**brown - Live, blue - Neutral**) into terminal block making sure all connections are tight.



GARDEN LED LIGHT

E286 WITH BASE 

Please read instructions before commencing installation and retain for future reference.

SPECIFICATIONS

- **Material:** Aluminum - Tempered Glass
- **Lamp type:** LED , 12W , 3000K , 780Lm , CRI 80
- **Ingress Protection:** IP65. Protection against entry of solid objects greater than 12mm in diameter.

INSTALLATION INSTRUCTIONS

 Electrical products can cause death, injury, or damage to property. Maintenance and installation should only be carried out by a professional electrician.

 The light source contained in this luminaire shall only be replaced by the manufacturer or his service agent or a similar qualified person.

- Ensure main supply is switched off.

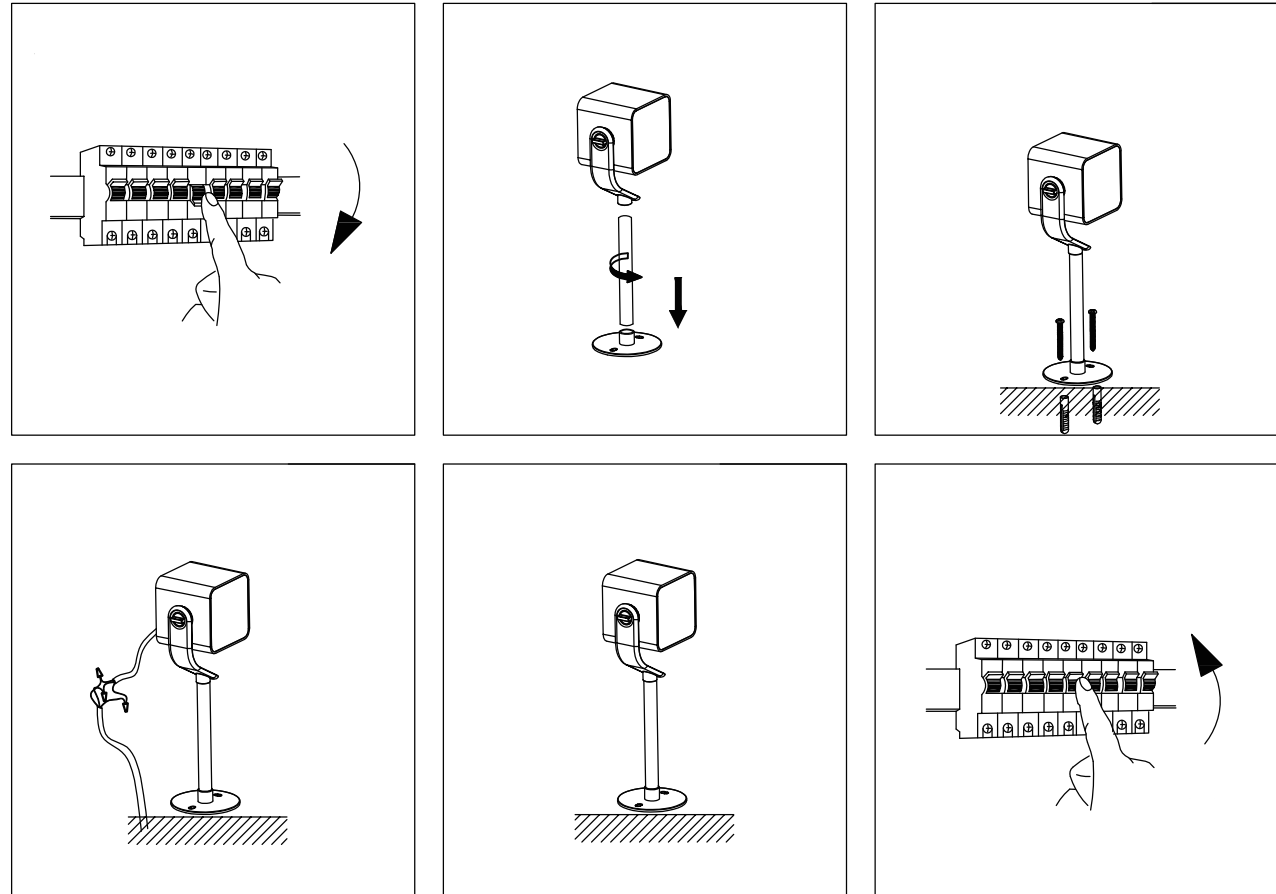
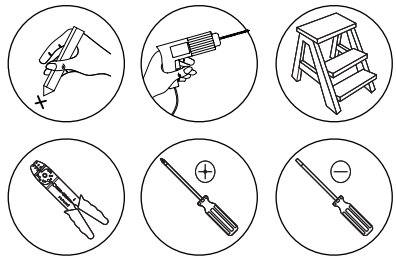

WARNING

- Make sure that the products is installed properly before connecting to electricity.
- Do not cover the fitting.

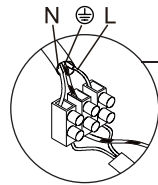

Connecting the Terminal Block

Connect main supply (**brown - Live, blue - Neutral**) into terminal block making sure all connections are tight.

