

### Connecting the Terminal Block

Connect main supply (brown - Live, blue - Neutral) into terminal block making sure all connections are tight.

7

1

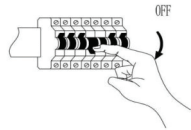

2

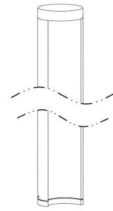

3

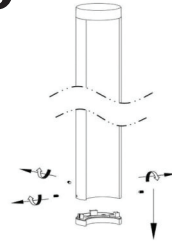

4



5



6

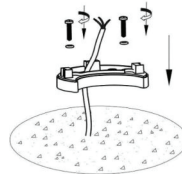

7

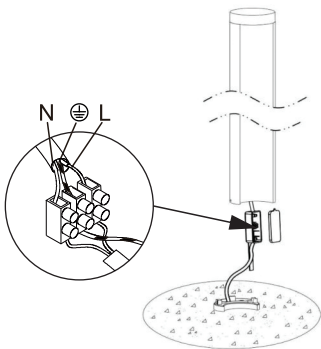

8

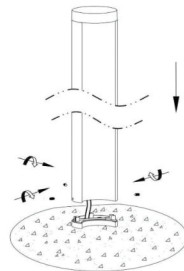

9

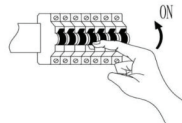

## OUTDOOR FLOOR LIGHT

E133

Please read instructions before commencing installation and retain for future reference.

### SPECIFICATIONS

- **Material:** Aluminum
- **Lamp type:** LED 12W 3000K
- **Ingress Protection:** IP54. Protection against entry of solid objects greater than 12mm in diameter.

### INSTALLATION INSTRUCTIONS

**!** Electrical products can cause death, injury, or damage to property. Maintenance and installation should only be carried out by a professional electrician.

- Ensure main supply is switched off.
- Carefully remove the product from its packaging (2) and unscrew the base (3).
- Measure and note the centers of the screws in the base, approx 85mm (2).
- Drill and insert the plastic plugs (5).
- Then run the power cord through the center of the base and screw the base firmly to the floor (6).
- Connect main supply wires to terminal block (7) making sure all connections are tight.
- Fix the fitting of light to the ground and twist on the screws (8)
- Reconnect power (9).

### WARNING

- Make sure that the products is installed properly before connecting to electricity.
- Do not cover the fitting.

