

Product Data Sheet

Date: 13/02/2023
www.zambelislights.gr

Code 22098

Color: Sandy Black



Trimless Curved Track Ø900mm

Voltage	48V
Dimensions	L: 942.5mm W: 55mm H: 55mm
Material	Aluminum

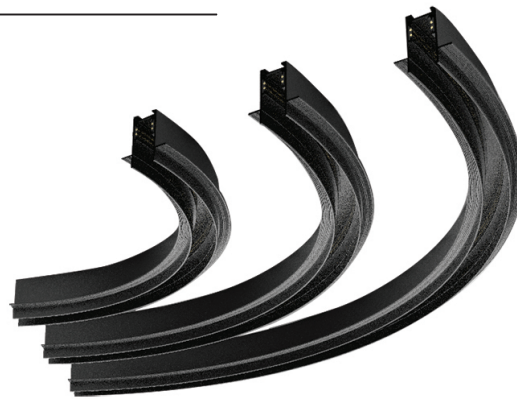

Description

48V Trimless Magnetic Curved Rail Ø90cm made of aluminum in a sandy black finish.

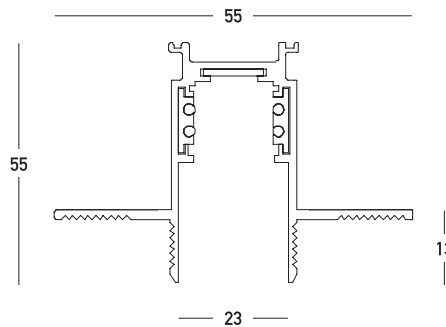

5213010019244



www.zambelislights.gr | www.zambelislights.com

