

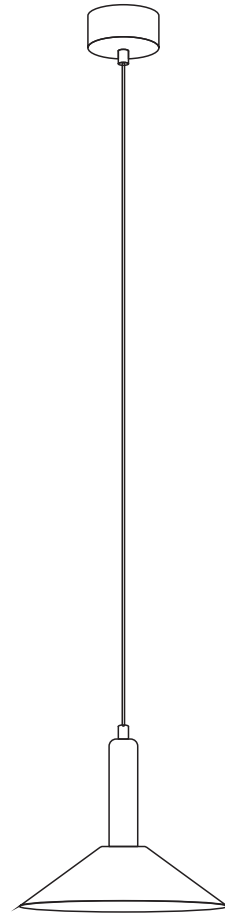

### Connecting the Terminal Block

Connect main supply (brown - Live, blue - Neutral) into terminal block making sure all connections are tight.

4

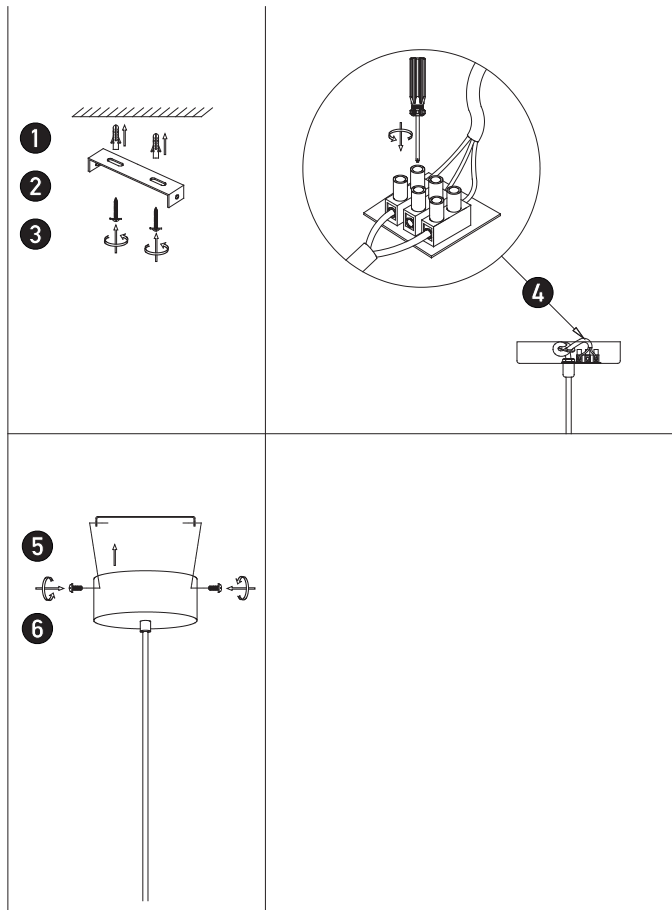

## PENDANT LIGHT

22183

Please read instructions before commencing installation and retain for future reference.

### SPECIFICATIONS

- **Material:** Metal + Aluminium
- **Lamp type:** LED , 7W , 3000K , 840Lm
- **Ingress Protection:** IP20. Protection against entry of solid objects greater than 12mm in diameter.

### INSTALLATION INSTRUCTIONS

**!** Electrical products can cause death, injury, or damage to property. Maintenance and installation should only be carried out by a professional electrician.

- Ensure main supply is switched off.
- Insert masonry plugs (1) into mounting surface.
- Fit mounting bracket (2) onto mounting surface with self-tapping screws (3).
- Connect main supply wires to terminal block (4) making sure all connections are tight.
- Fit ceiling plate (5) onto mounting bracket with screws (6).
- Reconnect power.

### WARNING

- Make sure that the products is installed properly before connecting to electricity.
- Do not cover the fitting.
- Not for outdoor use or in wet conditions.

