



Please read instructions before commencing installation and retain for future reference.

SPECIFICATIONS:

Lamp type: LED 6W 3000K

Lamps and gears excluded unless otherwise specified

Protection against electric shock: CLASS I, . Requires earth connection.

Ingress Protection: IP20. Protection against entry of solid objects greater than 12mm in diameter.

Quality/Corrosive rating: QC21: Burning period: 12hrs/24hr cycle. Commercial use, indoor mainly - painted or plated metals. Not for use in corrosive environments.

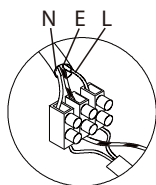

Connecting the Terminal Block

Connect main supply (brown - live, blue - neutral, green/yellow - earth) into terminal block making sure all connections are tight.

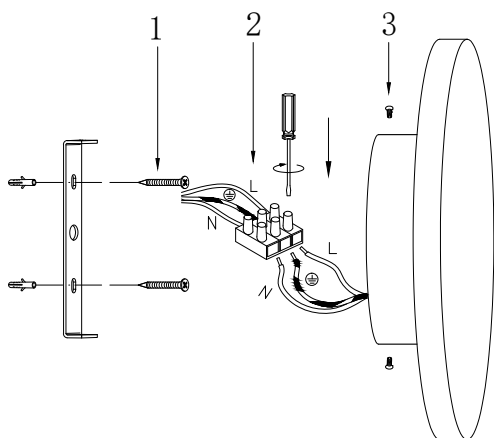

INSTALLATION INSTRUCTIONS:

⚠ Electrical products can cause death, injury, or damage to property. Installation of this product must be carried out by a qualified electrician.

- Ensure mains supply is switched off.
- Insert masonry plugs into mounting surface.
- Fit mounting bracket onto mounting surface with self-tapping screws(1) .
- Connect main supply wires to terminal block (2) making sure all connections are tight.
- Fit ceiling cup onto mounting bracket with screws (3).
- Reconnect power.

WARNING:

Not for outdoor use or in wet conditions.

