

### Connecting the Terminal Block

Connect main supply (brown - Live, blue - Neutral) into terminal block making sure all connections are tight.

6

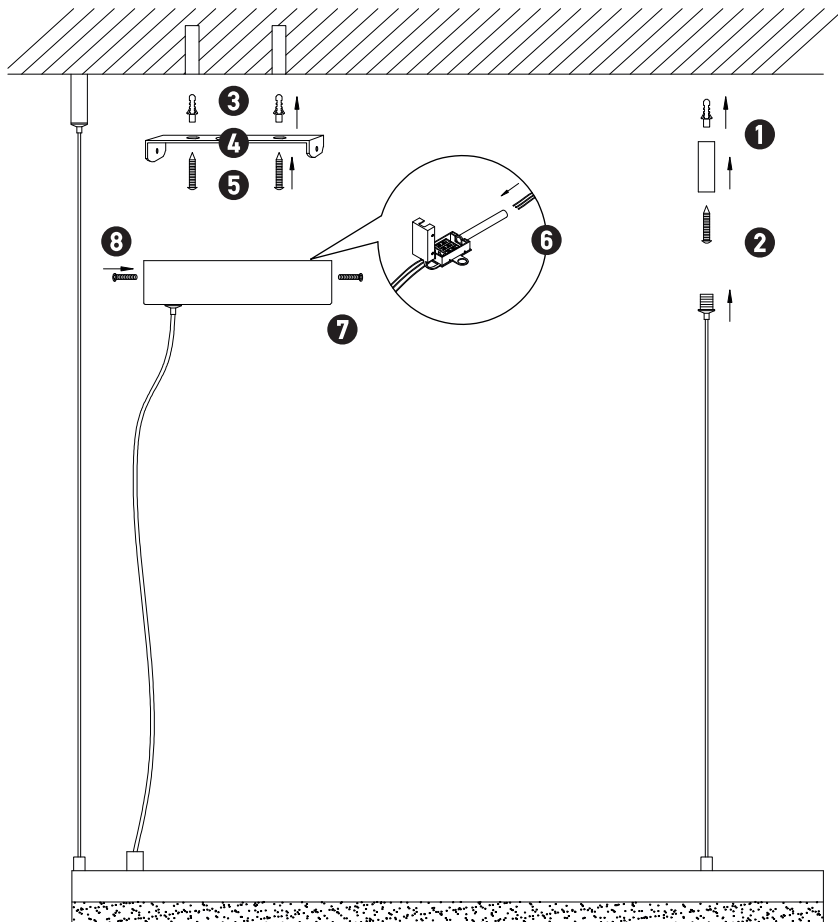

## PENDANT LIGHT 20262



Please read instructions before commencing installation and retain for future reference.

### SPECIFICATIONS

- **Fitting:** ALUMINIUM + ACRYLIC.
  - **Lamp type:** LED 55W 3000K
  - **Ingress Protection:** IP20. Protection against entry of solid objects greater than 12mm in diameter.
  - **Quality/Corrosive rating:** QC21
  - **Burning period:** 12hrs/24hr cycle. Commercial use, indoor mainly painted or plated metals.
- Not for use in corrosive environments.**

### INSTALLATION INSTRUCTIONS

**!** Electrical products can cause death, injury, or damage to property. Installation of this product must be carried out by a qualified electrician.

- Ensure main supply is switched off.
- Insert masonry plugs (1) into mounting surface.
- Fit the wire (2) onto mounting surface with self-tapping screws.
- Insert masonry plugs (3) into mounting surface.
- Fit mounting bracket (4) onto mounting surface with self-tapping screws (5).
- Connect main supply wires to terminal block (6) making sure all connections are tight.
- Fit ceiling plate (7) onto mounting bracket with screws (8).
- Reconnect power.

### WARNING

- Not for outdoor use or in wet conditions.

