

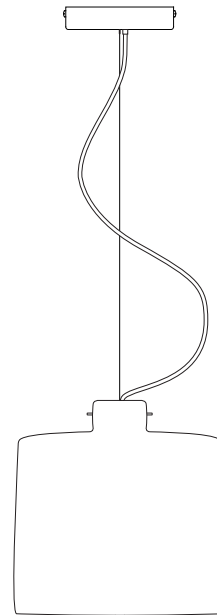

Connecting the Terminal Block

Connect main supply (brown - Live, blue - Neutral) into terminal block making sure all connections are tight.

4

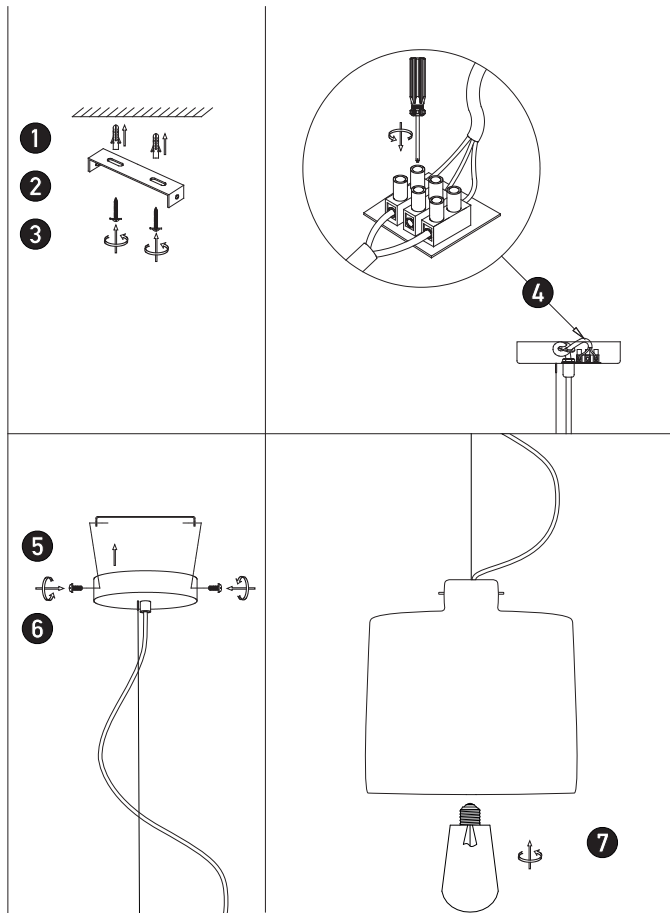

PENDANT LIGHT

1664

Please read instructions before commencing installation and retain for future reference.

SPECIFICATIONS

- **Material:** Clay
- **Lamp type:** 1xE27 , MAX 40W
- **Ingress Protection:** IP20. Protection against entry of solid objects greater than 12mm in diameter.

INSTALLATION INSTRUCTIONS

Electrical products can cause death, injury, or damage to property. Maintenance and installation should only be carried out by a professional electrician.

- Ensure main supply is switched off.
- Insert masonry plugs (1) into mounting surface.
- Fit mounting bracket (2) onto mounting surface with self-tapping screws (3).
- Connect main supply wires to terminal block (4) making sure all connections are tight.
- Fit ceiling plate (5) onto mounting bracket with screws (6).
- Fit E27 bulb firmly into lampholder (7).
- Reconnect power.

WARNING

- Make sure that the products is installed properly before connecting to electricity.
- Do not cover the fitting.
- Not for outdoor use or in wet conditions.