

### Connecting the Terminal Block

Connect main supply (brown - Live, blue - Neutral) into terminal block making sure all connections are tight.

4

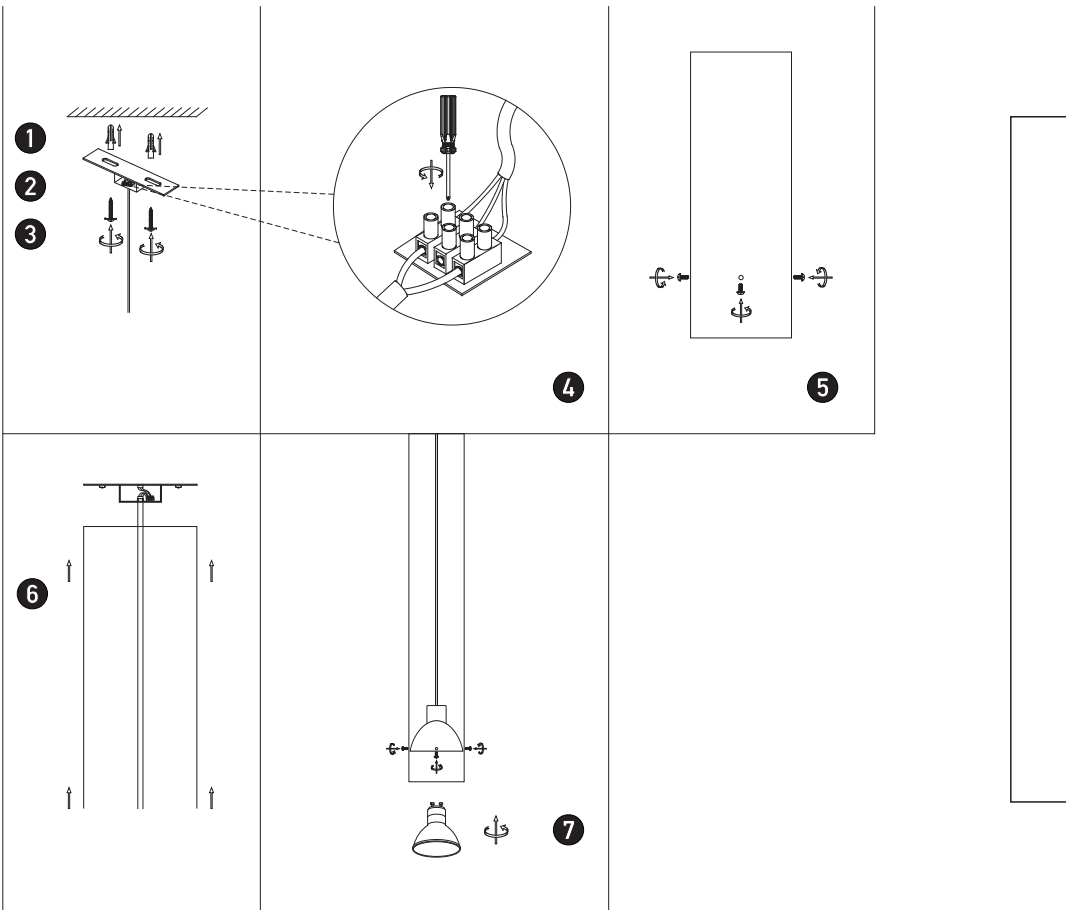

## CEILING LIGHT

1566-B

Please read instructions before commencing installation and retain for future reference.

### SPECIFICATIONS

- **Material:** Aluminium
- **Lamp type:** 1 x GU10 , MAX 40W
- **Ingress Protection:** IP20. Protection against entry of solid objects greater than 12mm in diameter.

### INSTALLATION INSTRUCTIONS

**!** Electrical products can cause death, injury, or damage to property. Maintenance and installation should only be carried out by a professional electrician.

- Ensure main supply is switched off.
- Remove the metal screw from the inside with the socket and connection wires.
- Insert masonry plugs (1) into mounting surface.
- Fit mounting bracket (2) onto mounting surface with self-tapping screws (3).
- Connect main supply wires to terminal block (4) making sure all connections are tight.
- Unscrew carefully the three small screws on the lights body (5).
- Insert the metal screw up to the height of the smaller ones and screwing them. Lights body moves slowly towards the mounting surface until it touches (6).
- Fit GU10 bulb firmly into lampholder (7).
- Reconnect power.

### WARNING

- Make sure that the products is installed properly before connecting to electricity.
- Do not cover the fitting.
- Not for outdoor use or in wet conditions.